

DB15 TSW 2

Potentiometer Installation Guide

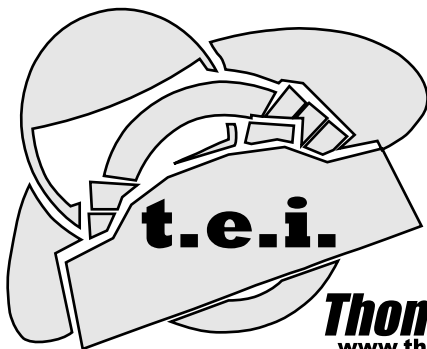

Thomas Enterprises, Inc.
www.thomas-superwheel.com

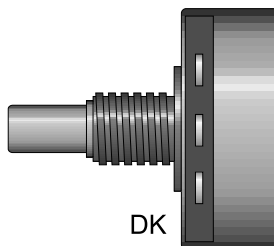
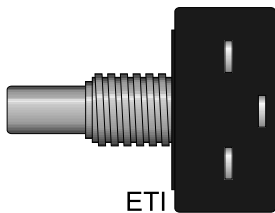
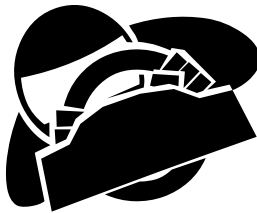

THOMAS ENTERPRISES, INC.
13859 Buffalo Road
Anamosa, IA 52205

Phone: (319)462-3327 7:00AM-4:00PM Monday through Friday
Fax: (319)462-3481

Web: www.thomas-superwheel.com
Email: service@thomas-superwheel.com

Potentiometer Replacement

Tools Required:



7/16"
Nut Driver



1/8"
Allen Wrench



Small Straight
Screwdriver



Medium
Phillips

A potentiometer is a device which translates mechanical rotation into variable resistance. The computer can read the variable resistance and translate that into a change in the steering, brake, or throttle in the game. There is one potentiometer in the steering controller, and one for each pedal for a maximum of 4 potentiometers, if your controller has a clutch pedal.

Potentiometers don't last forever, they do have a wear factor, and will eventually need to be replaced. The most common symptom of a failing potentiometer is when you experience erratic calibration behavior and/or twitchy behavior on-track. On average you can expect to get 6 months to 1 year out of the medium grade DK potentiometers, and about 2 to 3 years out of the high grade ETI potentiometers with heavy use.

With this in mind, we've designed our controllers so that replacing potentiometers is as easy as possible, and we've provided you with a detailed guide to show you how to change them out. With the right tools, anyone should be able to replace the potentiometers when the time comes.

To get at the potentiometers you first need to remove the plastic cover(s). The steering cover is held on by 5 phillips head screws. Remove these, and also unscrew the shift knob to remove the cover.

The Pedal cover is held on by 4 phillips screws, but you also need to remove the pedal pads before the cover can be removed. To do this, you need two 1/2" wrenches. Use one wrench to hold the nut and the other to loosen the bolt which secures each pedal pad.

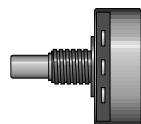

Medium Grade
DK Potentiometer

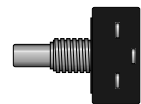

High Grade
ETI Potentiometer

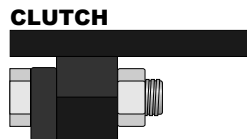
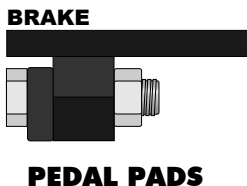
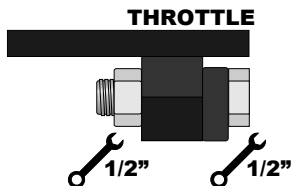

PEDAL PADS

Potentiometer Installation in Steering Controller

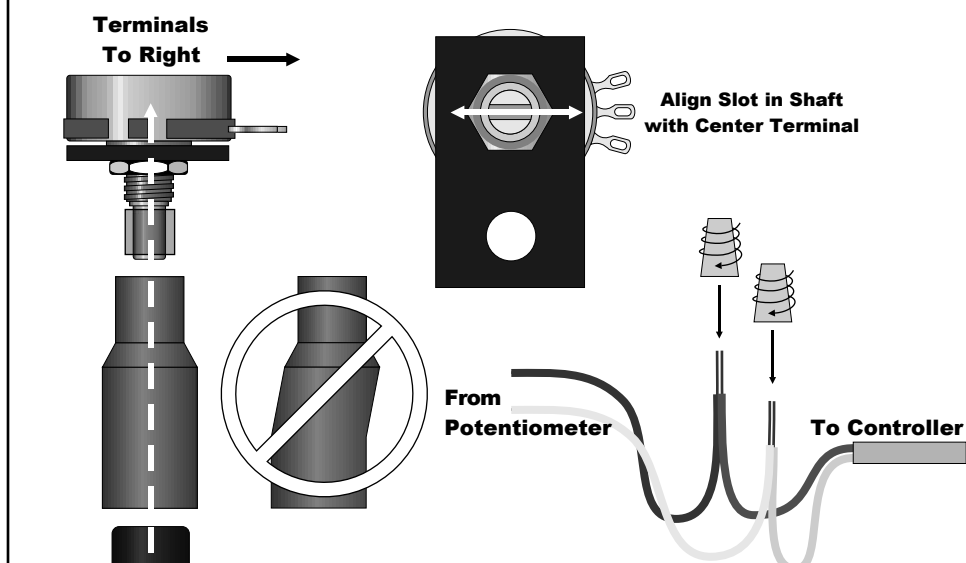
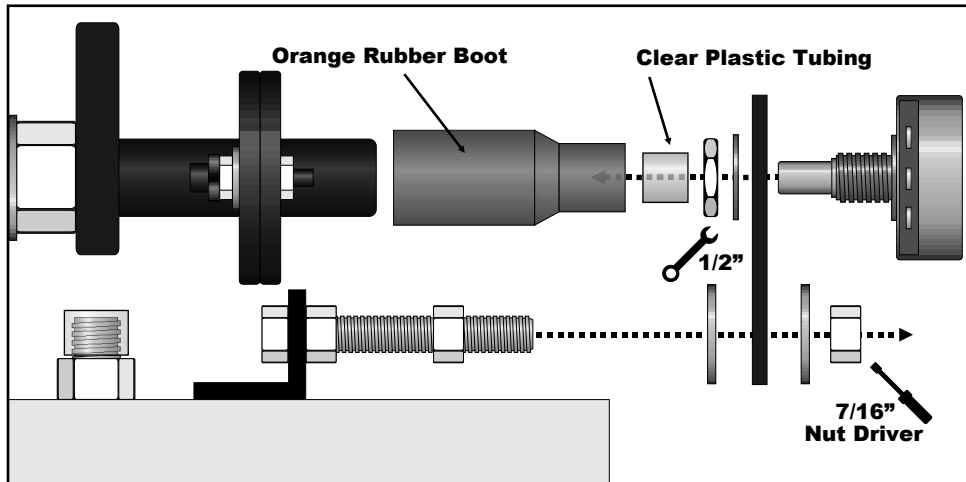

(Potentiometer Wiring viewed from above)

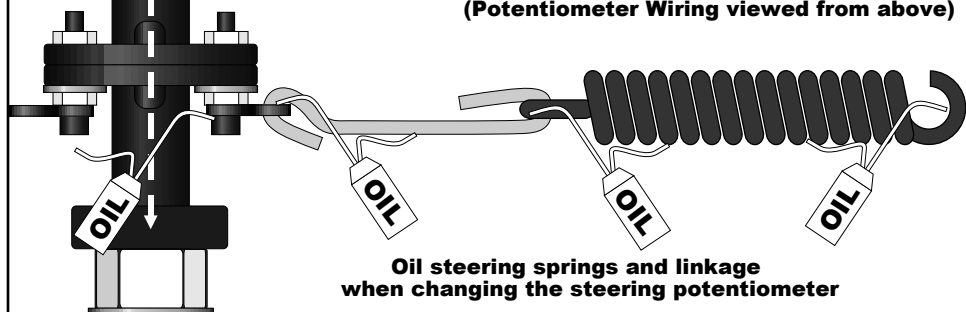

Oil steering springs and linkage when changing the steering potentiometer

Potentiometer Installation in Pedal Controller

Leave Minimal Gap

Leave Minimal Gap

THROTTLE

BRAKE

CLUTCH

1/2"

1/2"

1/2"

Pedal

Threaded Rod

Plastic Linkage Block

Potentiometer Bracket

Screwdriver Slot
(see next section)

1/8" Allen Wrench
(Don't tighten yet)

Use Small Straight Screwdriver
To Adjust Potentiometer Shafts

See Next Section For
Proper Settings

Setting/Adjusting the Steering Potentiometer

After installing the potentiometers, you will need to make final adjustments to ensure they are set properly. The best way to do this is to connect your controller to the computer and launch a Papyrus sim like Nascar 2003 or Grand Prix Legends. These games have useful in-game calibration screens which give valuable information needed to set the potentiometers. If you don't have one of these games, there are less accurate ways to set the potentiometers which will work but may not be ideal. You can also use a digital ohm-meter to display resistance values of the potentiometers, which is just as useful, if not quite as handy as the in-game calibration routines of the Papyrus sims.

With the steering controller, it is usually not necessary to make much of an adjustment. If you have aligned the potentiometer shaft correctly based on the illustrations in the previous section, aligning the slot with the center solder terminal, then you have already placed the potentiometer at it's approximate center, which is what you are trying to achieve while the steering wheel is also at it's center.

Not all pots are perfectly linear, in that they may not achieve their exact center resistance when their shaft is physically centered. Some even have more resistance change on one side of their center resistance than the other. This is not overly important as the game will compensate for these conditions when you calibrate, but it is possible to improve this condition somewhat by adjusting the potentiometer shaft to compensate. If you don't have a Papyrus sim to calibrate with, don't worry about this. If you do, then you can follow the instructions below to fine tune the potentiometer setting..

The way you do this is by first examining the calibration values on the steering axis after you have turned the wheel fully left and right. If the raw value (below center of axis) reaches its minimum value well before you have turned the wheel to it's counter-clockwise stop, then you will want to adjust the potentiometer shaft counter-clockwise. To make this adjustment, grip the orange rubber boot where it fits over the end of the steering shaft, hold the steering wheel with your other hand, and turn the rubber boot counter-clockwise. After this adjustment, you need to click OK to exit the calibration screen and then calibrate again to check that the changes you made produced the desired result. Ideally, the raw value should reach minimum right at the point you are at full left lock on the steering wheel.

You should also check for the opposite condition. When turning the wheel to the right, the raw should reach it's maximum value right at the point when the steering wheel is at full lock. If the maximum raw value is reached before you have turned the wheel to full lock, you should adjust the pot shaft in a clockwise direction, again by turning the orange rubber boot on the steering shaft. It may not be possible for you to achieve both ideal conditions, as some DK potentiometers have a little less travel than others. If this is the case, you should try to achieve a balance by leaving approximately the same amount of dead travel on both sides.

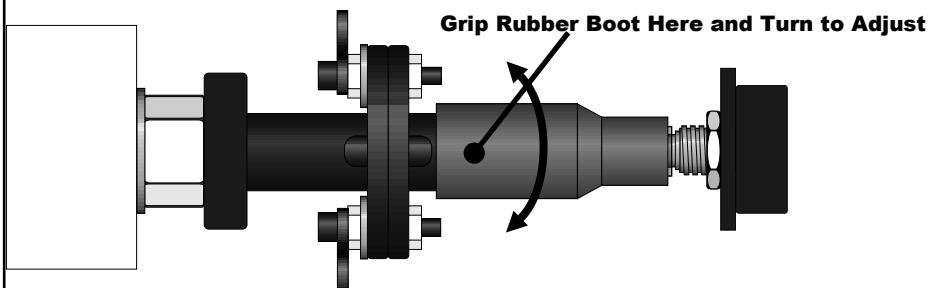

Setting the Pedal Potentiometers

Setting the potentiometers in the pedals is a bit more complicated than the steering controller, begin by situating the controller with the potentiometers closest to you, ideally with the pedal controller on your desk for easy access. It will be best to keep the controller connected to your computer so that you will be able to adjust the pots using a Papyrus sim's calibration screen as a guide.

With the factory potentiometer settings, which are optimized for split axis pedals, the Rockfire USB adapter will not work 100% effectively when the controller is operating with the pedals in combined mode. Using the USB adapter in combined mode with the factory settings will generally result in some dead travel on the brake pedal. If you race with some games that require combined mode, and others that use split mode, you should decide which is the most important to you. You will need to make a compromise. For the best performance using the USB adapter in combined mode, the potentiometers should be re-set using the combined only method detailed below. However, the combined only settings will not work ideally for split axis mode, potentially generating some cross-talk between gas and brake, thus slowing your car down slightly. If you must get the best performance out of games that need to use combined pedals, then it's recommended to use the combined only method, and run all your games using the combined mode. You might sacrifice some realism in games which support split axis pedals, but that is preferable to performance loss.

Combined Mode Only

If your controller is not capable of split axis mode, then use this section to properly adjust your pedal potentiometers. If you adjust your pedal pots using this method, it will be necessary to re-set them using the split axis method if you upgrade your controller with the single/dual adapter down the road.

Adjust the potentiometer shafts using the physical stop of the pot shaft as your guide. With the brake potentiometer, use a small straight screwdriver to turn the pot shaft counter-clockwise until it stops. Then turn the shaft back clockwise a small amount, not more than 1/8 turn. To lock the brake potentiometer in place, tighten the set screw in the bottom end of the pedal linkage block using a 1/8" allen wrench.

The procedure for the throttle is essentially the same, but it is a bit more difficult because you have to hold down the throttle pedal while adjusting the pot shaft and locking the potentiometer linkage in place. With one hand press down and hold the throttle pedal. With the other hand, turn the potentiometer shaft counter-clockwise using a straight screwdriver until the pot stops turning, then turn it back slightly. Finally, continuing to hold down the throttle pedal, use the 1/8" allen wrench to tighten the set screw in the pedal linkage block.

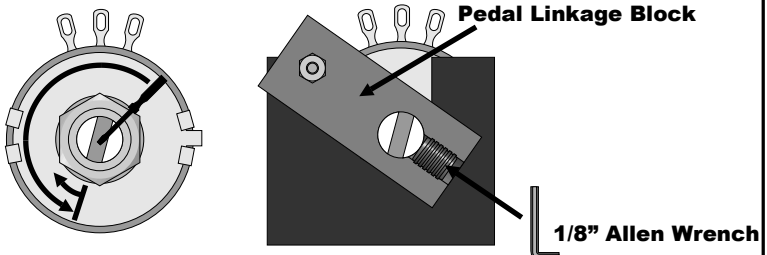

Split Axis Potentiometer Settings

With a controller which has split axis capability you should use the following method for setting the pedal potentiometers. This method is used to set the potentiometers at the factory. Again, it's going to be best to use an in-game calibration, preferably one of the Papyrus sims to gauge the values of the pots. Without this, or a digital ohm-meter, you will not be able to set the pots as accurately, however you can use the slot in the end of the pot shafts to get the settings close to ideal if not perfect. See the illustrations at the end of the section for setting the pots based off the screw driver slot.

It can be a bit difficult to explain the proper method for setting the pots using the calibration values. To this end, it's best to understand what you're trying to accomplish by adjusting the pot shafts.

The first thing to be aware of is that when you turn the pot shaft counter-clockwise, you are reducing it's resistance value, and subsequently the raw value on the calibration screen is also reduced, and of course the opposite applies, when you turn it clockwise, the value is increased.

Second, when using split axis mode, we've found that in most cases, having the raw values of the gas and brake reach an equal value will cause interference between the two pots. The affect of that is that some brake will be applied while pressing the gas, and some gas is applied when pressing the brake. Obviously this is to be avoided as it will likely hurt on-track performance.

Finally, it seems to be the case with potentiometers that the higher the resistance value, the more jitter you will experience. Therefore, you want to keep the pots at the lowest resistance values possible, essentially towards the counter-clockwise end of their travel, to minimize jitter.

With these things in mind, use the following procedure to set your potentiometers. Bring up your calibration screen. Use a small flat screwdriver to adjust the pot shafts (make sure the set screws are loose in the end of the pedal linkage blocks). Begin with the throttle potentiometer, turn it fully counter-clockwise and take note of the raw value on the axis that corresponds to the throttle. It should reduce to a low number probably below 10. Whatever the value of that number, add 20 to it and that is the number you need to keep in mind (we add 20 to create a safe cushion to prevent the possibility of having any dead travel). Let's assume that the raw number is 7 when the potentiometer shaft is fully counter-clockwise, the number to keep in mind then is 27, which for simplicity, we'll round up to 30. The number 30 is what we want to have as our raw value when the throttle pedal is pressed down.

To get this, press and hold down the gas pedal, then adjust the throttle potentiometer so that the raw value is 30. While continuing to hold down the pedal, tighten the set screw in the end of the pedal linkage block to secure it. You can then release the throttle pedal.

After letting up on the throttle pedal, you now need to take note of the raw value of the throttle axis. Whatever it's value, again, add 20 and this new number will determine the value setting of the brake pedal. Let's assume the raw value of the throttle is 310 when the gas pedal is up, we add 20, so the number to keep in mind is 330. Now, with your screwdriver, adjust the brake pot shaft till the raw value on the brake axis is 330. Once you have that, lock the pedal linkage block in place by tightening the set screw in the end.

If you've done this successfully, using the above numbers as an example (your numbers will be different), there will be a raw of 30 when the gas is pressed, and a raw of 310 when it is neutral. You will have a raw of 330 on the brake when it is neutral, and an undetermined number on the brake when it is pressed, probably around 600 or so based on the numbers we're using in this example. The main thing to note is that the gas reaches a low number when pressed, thus

Split Axis Potentiometer Settings (continued)

keeping the jitter at it's lowest when you are at full throttle, and also note that there is a bit of a gap between the ranges of the gas and brake, thus keeping them from ever having the same raw value which causes interference between the pedals.

Lastly, if you have a clutch pedal, you will need to set its pot shaft as well. Use the same raw value as the low value of your throttle pot, in this case 30. Adjust the pot shaft with the screwdriver till the raw value on the clutch axis is 30. Then lock the pot in place by tightening the set screw in the end of the linkage block.

Again, keep in mind that the numbers in this example are only estimates based on our computer, they will differ from computer to computer and potentiometer to potentiometer. The raw values you see on your calibration screen will be derived from the process described, not from the sample numbers we've provided.

Setting the Potentiometers without using a calibration screen

If you find the above procedures to be a bit too tough to follow, or you don't have an in-game calibration with raw values, you can use the slot in the end of the pot shafts to adjust the potentiometers. This method is not as accurate, but it will achieve acceptable ranges. Follow the illustrations below to determine the proper alignment of the pot shafts.

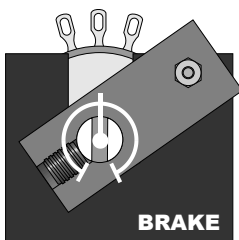
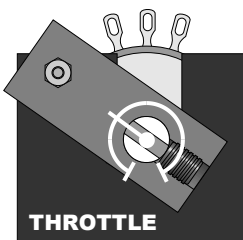

Setting DK Potentiometers Manually without in-game Calibration

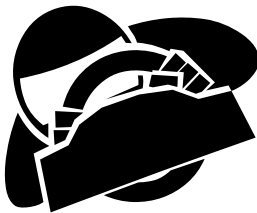

Thomas Enterprises, Inc.
www.thomas-superwheel.com

service@thomas-superwheel.com
(319)462-3327
13859 Buffalo Road, Anamosa, IA 52205